

TO-92 Plastic-Encapsulate Voltage Regulators

CJ78L06 Three-terminal positive voltage regulator

FEATURES

- Maximum output current
 $I_{OM}: 0.1A$
- Output voltage
 $V_O: 6V$
- Continuous total dissipation
 $P_D: 0.625 W (T_a = 25\text{ }^\circ\text{C})$

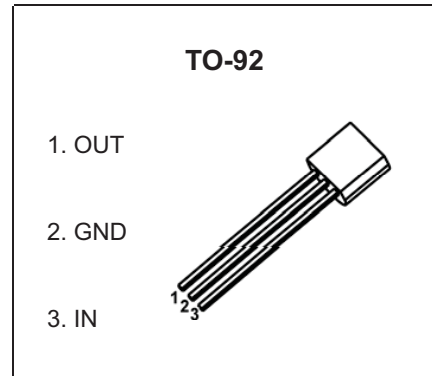

MARKING

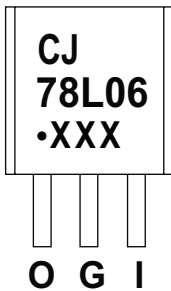

CJ78L06=Device code
 Solid dot=Green molding compound device,
 if none,the normal device
 XXX=Code

ORDERING INFORMATION

Part Number	Package	Packing Method	Pack Quantity
CJ78L06	TO-92	Bulk	1000pcs/Bag
CJ78L06-TA	TO-92	Tape	2000pcs/Box

ABSOLUTE MAXIMUM RATINGS (Operating temperature range applies unless otherwise specified)

Parameter	Symbol	Value	Unit
Input Voltage	V_i	30	V
Thermal Resistance from Junction to Ambient	$R_{\theta JA}$	160	$^\circ\text{C/W}$
Operating Junction Temperature Range	T_{OPR}	-25~+125	$^\circ\text{C}$
Storage Temperature Range	T_{STG}	-65~+150	$^\circ\text{C}$

ELECTRICAL CHARACTERISTICS

$T_a=25^\circ\text{C}$ unless otherwise specified ($V_i=11\text{V}, I_o=40\text{mA}, C_i=0.33\mu\text{F}, C_o=0.1\mu\text{F}$, unless otherwise specified)

Parameter	Symbol	Test conditions	Min	Typ	Max	Unit	
Output voltage	V_o	25°C	5.75	6.0	6.25	V	
		0-125°C	$8\text{V}\leq V_i\leq 20\text{V}, I_o=1\text{mA}-40\text{mA}$	5.7	6.0	6.3	V
			$I_o=1\text{mA}-70\text{mA}$	5.7	6.0	6.3	V
Load Regulation	ΔV_o	$I_o=1\text{mA}-100\text{mA}$	25°C	16	80	mV	
		$I_o=1\text{mA}-40\text{mA}$	25°C	9	40	mV	
Line regulation	ΔV_o	$8\text{V}\leq V_i\leq 20\text{V}$	25°C	35	175	mV	
		$9\text{V}\leq V_i\leq 20\text{V}$	25°C	29	125	mV	
Quiescent Current	I_q		25°C	3.9	6.0	mA	
Quiescent Current Change	ΔI_q	$9\text{V}\leq V_i\leq 20\text{V}$	0-125°C		1.5	mA	
	ΔI_q	$1\text{mA}\leq I_o\leq 40\text{mA}$	0-125°C		0.1	mA	
Output Noise Voltage	V_N	$10\text{Hz}\leq f\leq 100\text{KHz}$	25°C	46		$\mu\text{V}/V_o$	
Ripple Rejection	RR	$9\text{V}\leq V_i\leq 19\text{V}, f=120\text{Hz}$	0-125°C	40	48	dB	
Dropout Voltage	V_d		25°C	1.7		V	

* Pulse test.

TYPICAL APPLICATION

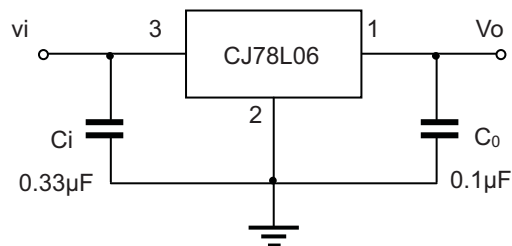

Note : Bypass capacitors are recommended for optimum stability and transient response and should be located as close as possible to the regulators.

Typical Characteristics

Output Characteristics

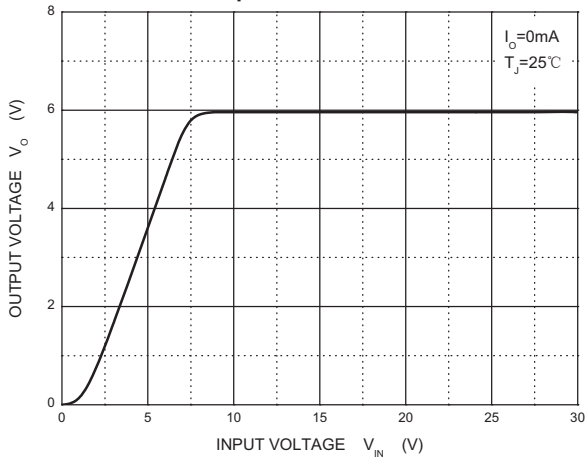

Dropout Characteristics

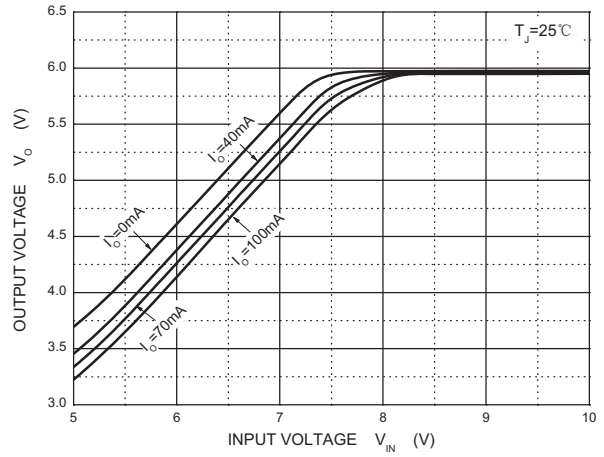

Quiescent Current

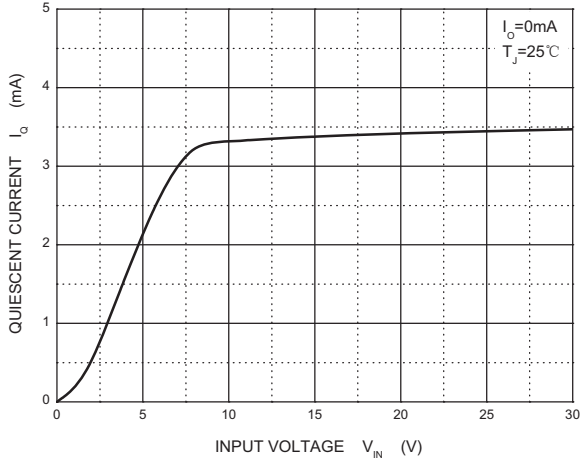

Current Cut-off Grid Voltage

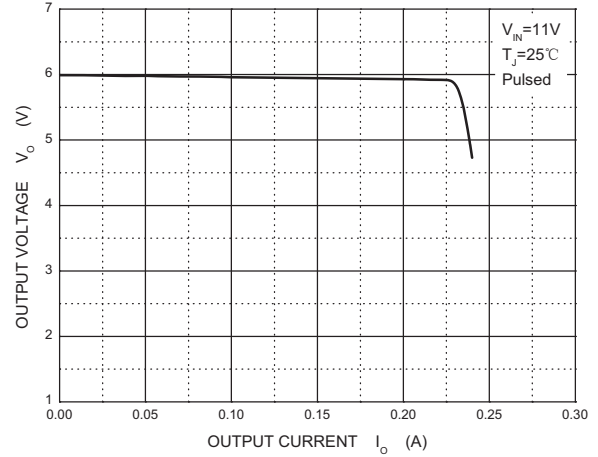

Output Voltage vs Junction Temperature

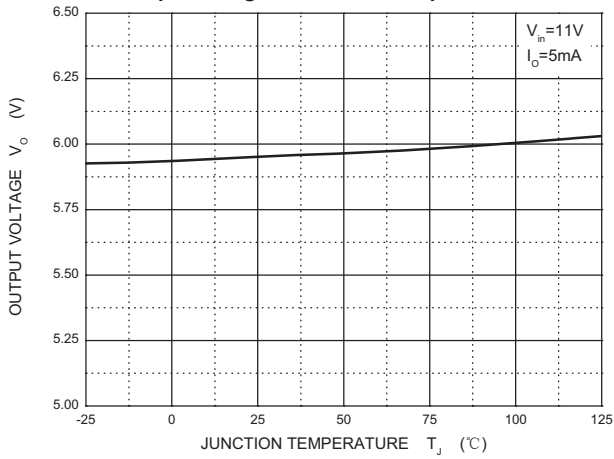

Power Derating Curve

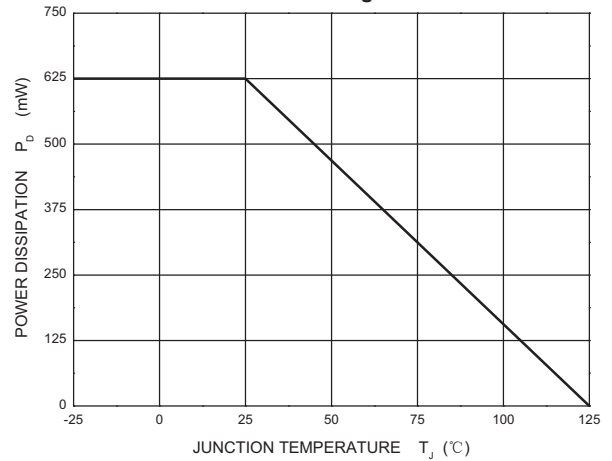

TO-92 Package Outline Dimensions

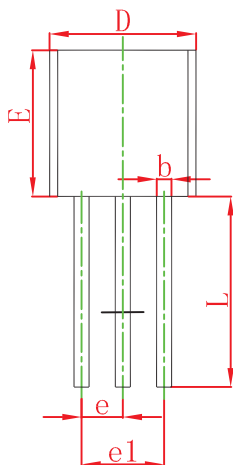
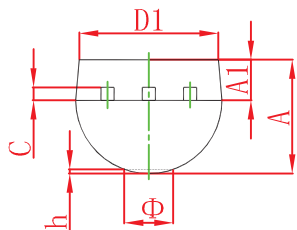

Symbol	Dimensions In Millimeters		Dimensions In Inches	
	Min	Max	Min	Max
A	3.300	3.700	0.130	0.146
A1	1.100	1.400	0.043	0.055
b	0.380	0.550	0.015	0.022
c	0.360	0.510	0.014	0.020
D	4.400	4.700	0.173	0.185
D1	3.430		0.135	
E	4.300	4.700	0.169	0.185
e	1.270 TYP		0.050 TYP	
e1	2.440	2.640	0.096	0.104
L	14.100	14.500	0.555	0.571
Φ		1.600		0.063
h	0.000	0.380	0.000	0.015

TO-92 Suggested Pad Layout

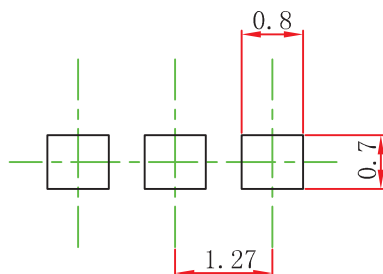

Note:

1. Controlling dimension: in millimeters.
2. General tolerance: $\pm 0.05\text{mm}$.
3. The pad layout is for reference purposes only.

NOTICE

JCET reserve the right to make modifications, enhancements, improvements, corrections or other changes without further notice to any product herein. JCET does not assume any liability arising out of the application or use of any product described herein.

TO-92 PACKAGE TAPEING DIMENSION

TO-92 PACKAGE TAPEING DIMENSION

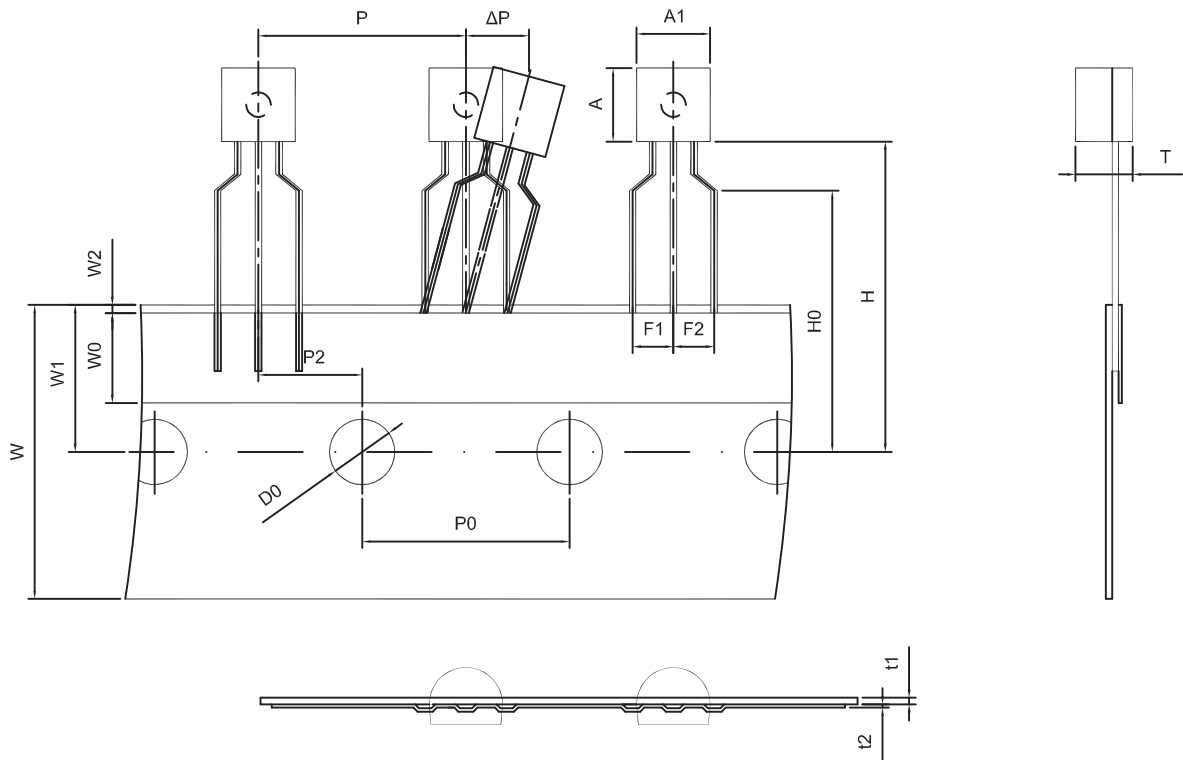

Dimensions are in millimeter

A1	A	T	P	P0	P2	F1	F2	W
4.5	4.5	3.5	12.7	12.7	6.35	2.5	2.5	18.0
W0	W1	W2	H	H0	D0	t1	t2	ΔP
6.0	9.0	1.0 MAX.	19.0	16.0	4.0	0.4	0.2	0

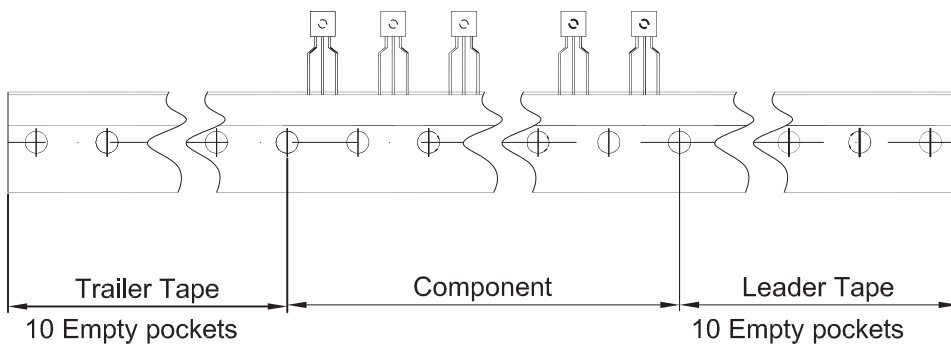

Package	Box	Box Size(mm)	Carton	Carton Size(mm)
TO-92	2000 pcs	333×162×43	20,000 pcs	350×340×250